

TOLERANCES (UNLESS SPECIFIED)	
0-10mm	±0.2mm
10.1-50mm	±0.5mm
50.1-250mm	±1.0mm
>250mm	±2.0mm

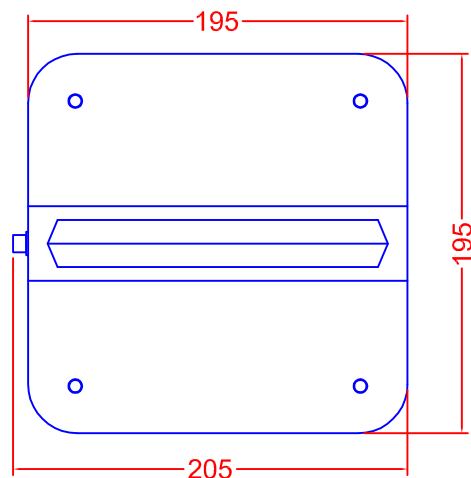
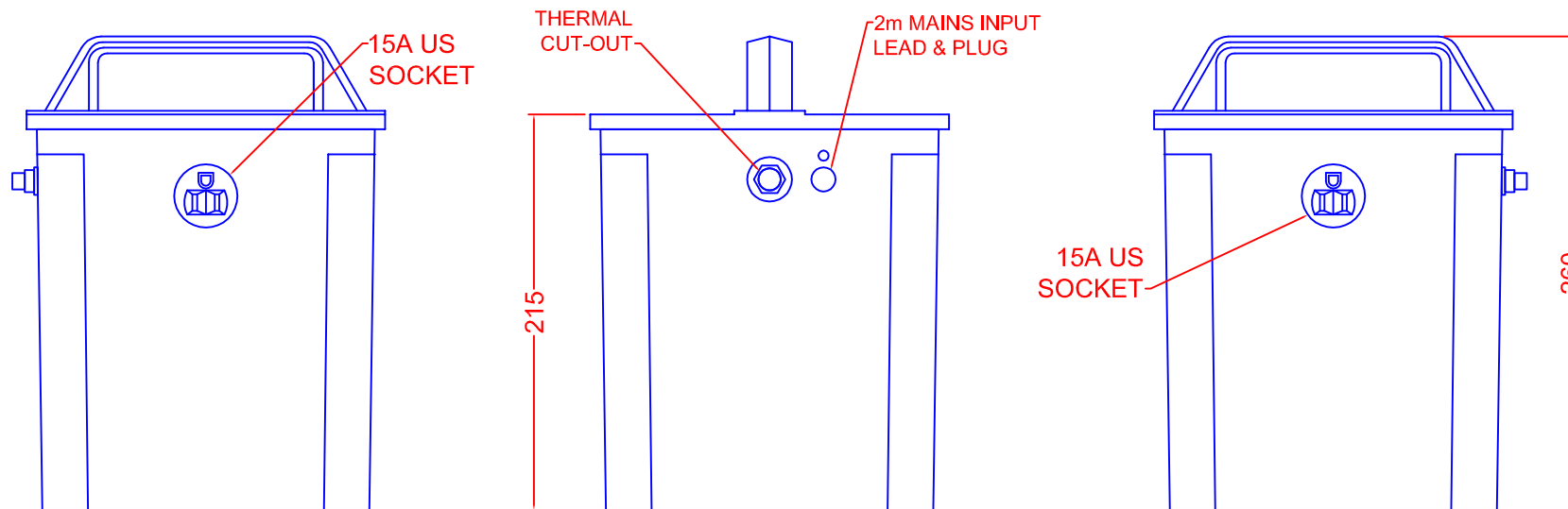

PORTABLE AUTO TRANSFORMER
 TYPE: STEP DOWN AUTO
 INPUT: 230V 50Hz
 OUTPUT: 115V
 RATING: 1KVA CONTINUOUS
 THERMAL CUT-OUT: 5A
 OUTPUT SOCKET: 2x15A AMERICAN
 NEMA CONFIGURATION 5-15
 INPUT PLUG: 13A BS1363
 ENCLOSURE: GRP
 RATED IP55
 COLOUR: WHITE

REV	
4	
3	
2	
1	

CARROLL & MEYNELL
 TRANSFORMERS LIMITED
 TEL: 01642 617406 FAX: 01642 614178
 enquiries@carroll-meynell.com

TITLE **PORTABLE
 AUTOTRANSFORMER
 CM1000/A/US**
 ALL DIMENSIONS IN mm

DRAWN	PROJECTION	DATE	SCALE
SH		26/4/8	NTS
DRAW No	REV	PAGE	
3269	0	1/1	